



Electric winch instructions manual

8000

Thank you for purchasing KANGAROOWINCH – and congratulations on the good choice. We hope that it will be useful for a long time and that each use will be a helpful experience.



Read the following manual carefully. Keep it in an easily accessible place near the winch so that you can consult it when in doubt. Follow all the rules when installing the winch, connecting it to the electrical system, and operating it.























Prior to working with the winch, please become acquainted with the safety rules and apply them, in the interests of personal safety as well as that of any bystanders. Any improper use of the winch can lead to property damage, human injury or even death.



Do not disregard the first start of the winch. Only in this way you can calmly get to know it and understand its operation.



Never operate the winch under the influence of alcohol, drugs or medicines. If you are below the legal age for operating the winch, use only in the presence of a legal guardian.

 Read all of the booklet carefully	 Danger	 Use personal protective equipment
 Use protective gloves	 Use a strap to hook	 Attach the hook properly to the load
 There is a risk of limb damage	 Insulate all cords and connections	 The rope must always be wound from the bottom of the winch
 Do not wind the rope over the drum from above	 Do not put wires on sharp edges	 Do not lay cords next to movable parts
 Do not use for lifting loads	 Do not use for transporting people	 Do not use to secure a cargo
 Do not attach the hook around the rope	 Risk of injuries to limbs	 Risk of burns
 Fire hazard	 Explosion hazard	

General safety rules

1. Correct clothing:

- DO NOT wear loose fitting clothes or jewellery as they can be caught in the movable parts of the winch
- Use protective gloves when working with the rope. Never grab the rope with your bare hands..

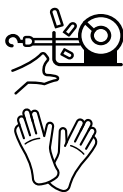

2. Keep a safe distance

- Do not get too close to the rope
- Make sure that there are no bystanders within a distance of 1.5 times the length of the rope. This is a safety measure in the event of a rope breaking, which could cause serious injuries or even death.
- Never cross or stand over a stretched rope
- Maintain a stable body posture, and be careful not to fall on or under the rope

3. Take care of the remote control cord

- NEVER carry or move the winch using the cord. Do not pull the cord to take the remote control plug out of the socket
- Keep the cord away from sources of high temperature, oil and sharp edges



4. Do not overload the winch

- If the motor warms up to such a temperature that it cannot be touched, stop working immediately and allow it to cool down
- Stop working immediately when the motor stops because it is unable to pull a load that is too heavy; use a pulley block and wait until the motor cools down
- Do NOT exceed the specified maximum pulling force of the winch; avoid jerking

5. Avoid accidental start-up

- Install a main breaker switch (jack) for the winch on the positive power lead (if in doubt when choosing this switch, contact your supplier)
- Always disconnect the power supply when you are not using the winch
- Switch off the wireless control unit with the button on the relay box (if present) and switch off the wireless remote control itself with the button/s placed on the remote control.

6. Maintain the technical condition of the winch

- Before starting the work, check the condition of the winch – any damage should be repaired as soon as possible by an authorized service centre; replace worn parts on a regular basis
- Use genuine spare parts only.
- Make sure that the rope is properly wound around the drum
- Keep the rope under a small load during winding; the rope must be wound around the drum under a minimum 5% load of the rated pulling force of the winch
- Wind the rope at right angles to the axis of the drum; in case of winding it at a different angle, make sure the rope is not wound on the drum in one place only – it may damage the winch or result in bodily injury or even death
- Do not let the rope move freely in the palm of your hand, even if you are wearing gloves – always use the special strap attached to the hook. Wind the rope according to the markings on the winch.

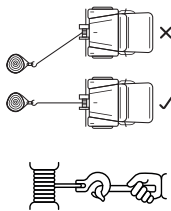

Using other devices or accessories than those recommended herein may result in personal injury.



Rules of safe winch handling



Failure to follow these rules may cause an accident, resulting in personal injury or property damage. Familiarize yourself with all the rules in detail.

Small irregularities in rope winding will not cause a problem unless the rope starts to accumulate on one side of the drum. If this happens, unwind the rope a little and unload the winch, then move the hooking point of the rope closer to the longitudinal axis of the vehicle on which the winch is mounted. After finishing work, you should always rewind the rope evenly – this will increase its longevity as well as comfort and safety of work.

- Keep the both the wired and wireless remote controls in a safe place. Inspect these before use
- Connect the remote control before turning on the clutch.
- NEVER move the clutch lever when the motor is turning.
- NEVER move the clutch lever under load.
- NEVER attach the hook directly around the rope, e.g. after wrapping the rope around a tree, as this will damage the rope. Always use an extra chain or strap/belt and a shackle.
- Watch the winch during its operation, but remember to keep a safe distance. Stop the winch every few meters to make sure that the rope is winding properly and evenly. Do not use the winch if you do not see the load being pulled or the anchor point or the rope.
- Do not attach additional hook holders to the winch mounting plate. The hook holders must be attached directly to the chassis frame.

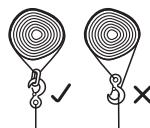

- Always use a pulley block when exceeding two-thirds of the maximum pulling force of the winch. This shall significantly increase its lifespan. The pulley block may also facilitate even winding of the rope on the winch drum.
- Make sure you use certified shackles, pulley blocks, chains and straps/belts only. The ultimate breaking force must match the winch pulling force. If in doubt, contact your supplier].
- NEVER unwind the entire rope. At least five wraps must ALWAYS remain on the drum, as otherwise the rope may be detached from the drum and cause an accident.

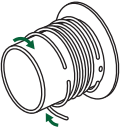
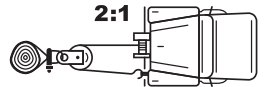

You can replace the steel rope with a synthetic one, but it MUST have adequate strength that matches the strength of the winch. Pay attention to the secure and correct fastening of the rope to the drum and the quality of the rope. For advice on choosing a suitable rope, contact your supplier.

- The maximum pulling power of the winch shall be achieved only with the first layer of the rope wound on the drum. To pull heavy loads, unwrap as much rope from the drum as possible and/or use a pulley block.



Final layers = minimum pulling force (~50-60%)*
Middle layers = average pulling force (70-80%)*
First two layers = maximum pulling force (90-100%)*

*approximate values have been provided

- Hang a heavy blanket or a specially designed plastic sheet on the rope (at around half of its length) to limit the strength with which the rope shall bounce off should it break.
- Wind the rope on the drum tightly, coil to coil, so that the upper winds of the rope do not cut into the lower layers. Should it happen, try to release the rope by pressing the winding on and unwinding buttons for short periods. NEVER release the rope under load by hand.
- The rope:
 - make sure it is properly fixed to the drum

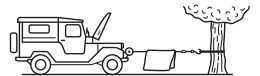

- Do not use a rope that is frayed, kinked and/or if pieces of wire protrude from it

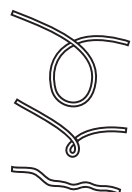

a) twisted rope

b) kinked rope

c) rope repeatedly kinked and loaded / a frayed rope



- do not use the winch rope as a tow rope (do not tow using a winch)
- do not replace the original rope with a rope of lower strength (before exchanging the rope, contact your supplier)
- do not use the winch rope to fasten a cargo
- the lifetime of the rope depends primarily on the way it is used. Wind the rope on the drum under a load of at least 5% of the pulling power, otherwise the top layers may cut into the lower layers, which may damage and permanently wedge the rope together.



- For the first start-up of the winch, aim at getting to know its operation in a quiet place, without the need to pull the hook under load. Unwind the rope until there are only five wraps left on the drum and then wind it again, under a slight load (about 5-10% of the pulling power). This will cause the rope to be slightly taut and allow it to be tightly wrapped around the drum.

If the rope is not wound evenly at the end of the task/s, it should be unwound and wound evenly and tightly onto the winch drum.

- Place wedges under the wheels of vehicles parked on a slope.
- Battery:

- must be in good condition
- avoid contact with electrolytes
- always wear safety glasses when working with the battery
- do not lean on the battery
- do not put wires on the terminals
- do not short-circuit the terminals with metal objects
- when using the winch, leave the engine running so that it can recharge the battery



- NEVER exceed the maximum pulling force of the winch.
- When pulling, do not "help" using the wheels of the vehicle, because you may cause jerks that exceed the capabilities of the rope or winch and cause damage.
- Avoid any jerks and violent force applied to the rope and the winch, because in such situations the winch is likely to be damaged and the rope may break.
- The KANGAROOWINCH winches are designed for use on vehicles and boats. They are not suitable for industrial applications.
- NEVER use the winch for lifting loads vertically.. The crane winches designed for this purpose have a completely different design.
- NEVER use the winch for lifting or transporting people.
- NEVER carry the winch by holding it by the clutch lever.
- On occasion the clutch lever may become slightly blocked. Try to turn the lever with one hand, and alternately press the buttons for winding and unwinding the rope on the remote control with one hand, so that the gear teeth mesh.



Never carry out the above procedure when the winch is under any load.

Assembling the winch



First, fix the winch correctly using all screws supplied and all elements of the mounting plate. Only start the electrical connection when you are sure that it is mechanically fully mounted.

1. Mounting the winch

The winch should be fastened with the screws provided, on a flat surface with adequate strength for the maximum pulling force. Depending on the model, there may be two, four or eight screws in the set. All bolts must be placed in the same plane, in holes with appropriate spacing to avoid damage to the winch. Make sure that the installation method does not interfere with operation of the sensor systems, i.e. those related to activation of the airbags or other systems in the vehicle, e.g. radar.

The assembly of the winch, depending on the model and the mounting plate, may require the replacement of the vehicle suspension system. If in doubt, contact your dealer. Use only mounting plates from renowned manufacturers.



Never make the mounting plate yourself.. you do so entirely at your own risk, because an incorrectly designed and/or poorly made mounting plate may damage the equipment, risk human health or life and shall always result in cancellation of the warranty.

The winch should be fastened using all the screws, nuts and washers supplied. Install the cable guide in such a way as to ensure that the rope is properly wound on the drum. Make sure that the screws holding the roller guide do not contact the winch mounting flanges, and the winch attachment bolts are the right length.

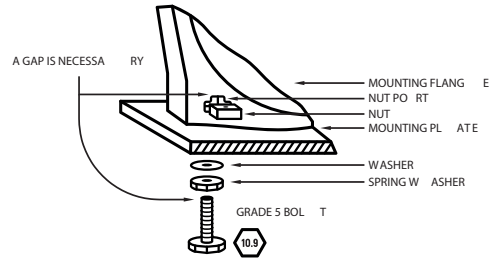

Attach the cable guide so that the warning sticker is clearly visible.

2. Lubrication

All moving parts of the winch have been pre-lubricated and do not require any further maintenance before first use. The steel wire rope requires periodic lubrication with oil.

3. Rope installation

Stretch the new steel wire rope on the ground, avoiding knots and kinks. Uncoil the old rope to the end and note how it was attached to the drum, then undo it.



When replacing the steel wire rope with a synthetic rope, make sure that it withstands the maximum pulling force of the winch. Follow the instructions provided by the rope manufacturer. Pay special attention to the number of coils that must remain on the drum and how to attach the rope to the drum. Contact your supplier for advice on choosing the correct rope.



4. Mounting the box with relays

The box with relays can be attached directly to the winch or to the vehicle itself in various ways. The best method of fastening should always be determined by practical requirements, both in terms of using the winch and the feasibility of assembly. In a vehicle that often enters deep water and mud, mount the box high under the hood.

MOUNTING OF 8000 BOX

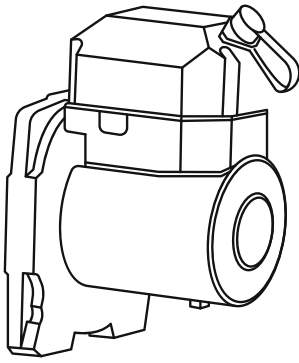

All connections should be securely tightened using screws with spring washers. Inaccurate connections may result in sparks, short circuits and may supply a too low current to the motor of the winch.



Always protect exposed electrical connections by means of protector caps and/or copper grease, especially if the winch is used in adverse conditions.

- The battery must be in good condition.
- Make sure that the wires are not exposed to damage by contact, for example with a hot engine, sharp edges, etc.
- Corrosion on the connection terminals will weaken the capabilities of the winch and can cause a short-circuit or damage.
- Clean all surfaces of connections (contacts) on a regular basis.
- If you work in a corrosion aggressive environment, use additional protection on connection terminals.

5. Connection to the power supply (battery)



Please read the following information carefully before connecting. **All bolts on the motor are equipped with a nut and counter nut. When tightening the wires, it is IMPERATIVE to secure the counter nut with the wrench so that the bolt does not turn. Turning the bolt may damage the internal electrical connections in the motor.**

If the wires delivered with the winch are too short, enlarge their cross-section in accordance with an increase in length thereof.

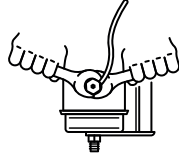

From the wiring diagrams presented below, choose the one appropriate for your winch model. Following these instructions, connect the winch to the power supply according to the diagram.

Step 1. Connect the free end of the long BLACK wire to the negative [-] pole of the battery*.

Step 2. Connect the free end of the long RED wire to the positive [+] pole of the battery**.



* Always connect the black wire directly to the battery only. Never use any other grounding available on the vehicle.



**The red wire must be fitted with a safety circuit breaker and a fuse.. When connecting the fuse, make sure it is properly installed. There is a marking to indicate which connector should be connected to the wire to the battery and which to the wire to the motor.



When routing the wires, make sure that they are not placed next to movable parts that may break the insulation or wire.



Never place wires on sharp edges that may cut the insulation or wire. Do not let the wires touch surfaces that may get hot.

WIRING DIAGRAMS

8000

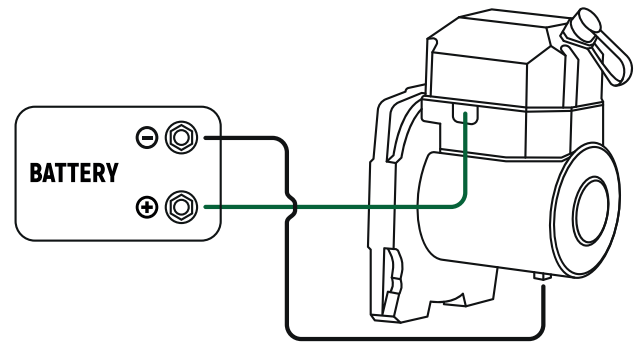

Using the winch



Analyse the situation and take your time to choose the right place for attaching the rope (the anchor point) and pulling techniques.

Practise using the winch before you actually need to use it. Do this several times in different conditions. Plan each attempt beforehand and pay attention to the sounds issued by the winch, depending on the level of load. Try to remember them because this shall be helpful in later use.

1. Lock the vehicle in place using the hand brake or chocks placed under its wheels.
2. Select the appropriate anchor point.
3. Unwind the amount of rope needed to hook it to the anchor point.

A minimum of five full coils of rope must be left on the drum.. Do not unwind the rope with the motor; disengage the drum and unwind the rope by hand instead.

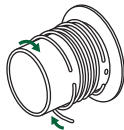

A. Disconnect the clutch by moving the lever to the "disengaged" (OUT) position. Now you can easily unwind the rope from the drum with your hands.

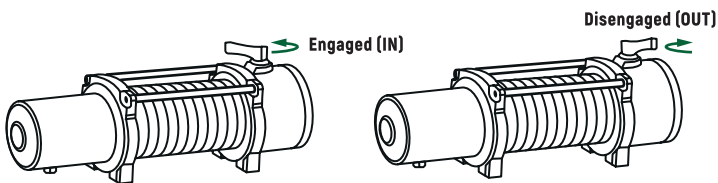

8000

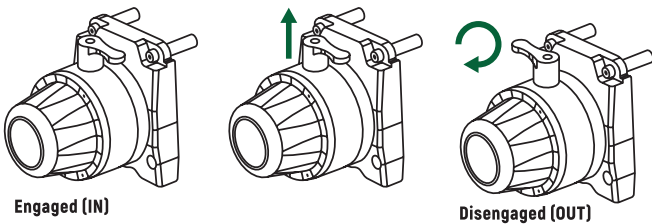

B. After unwinding the rope to the required length, activate the clutch by moving the lever to the "engaged" position (IN). The winch is ready for operation.

Make sure that the clutch is fully engaged prior to winding.. To do this, pull the rope firmly with your hand to make sure that the drum is engaged (the most common sign of this is a characteristic clicking in the gearbox).

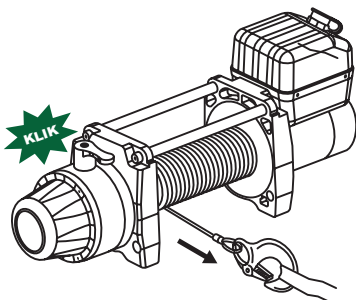

Wrap the anchor point (tree, stone, etc.) with a belt or chain, fasten the ends of it with a shackle. The hook of the rope should be attached to the shackle.



- Ensure that the latch of the hook is closed, and it does not bear the load.
- Do not apply the load on the tip of the hook or the latch. The load must be placed in the middle of the hook throat.
- NEVER use a deformed hook

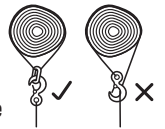

4. Check the correctness of connecting the power wires (before the first use and after each service or disassembly).

5. Insert the remote control plug into the socket on the relay box. We recommend controlling the winch from the inside of the vehicle, for greater safety in the event the rope gets broken. To do this, drag the remote control cord along the hood to the cab or contact your supplier to purchase an additional control set designed for use in the vehicle cab.
6. Prior to starting pulling, put the gearbox in the idle position and switch on the engine of the vehicle, then apply the handbrake.
7. Turn on the winch power supply using the main switch (jack).
8. Control the winch with the buttons IN and OUT.

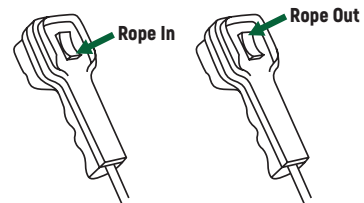

8000



9. Wind in the excess of rope so that the rope, belt/chain and shackle become taut. Now check again that all elements are correctly connected. If not, LOOSEN THE ROPE, IMPROVE THE FASTENING, and repeat the action.

10. When the system is connected correctly, you can start winding.

11. REMEMBER to release the handbrake.

12. Every now and then, check that the rope is properly winding around the drum. If necessary, stop winding and secure the vehicle, then lengthen that part of the rope and wind it evenly on the drum. Hook up the vehicle again and continue pulling.



13. ALWAYS unplug the remote control after pulling is completed. Depending on the model, the plug may have a protection that must be released to take the plug out of the socket.

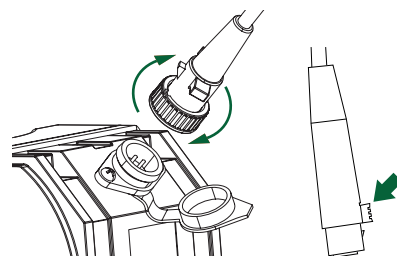

Depending on the model, the plug may have a protection that must be released to take the plug out of the socket.

Using the wireless remote control

The versatile wireless control system (STANDARD, XT, XT + or PROFI) includes both a control unit (receiver) and a transmitter (remote control). If you have bought a winch with a remote control included, the control unit is in the box with the relays. If you have purchased an additional wireless control system, connect it according to the wiring diagram enclosed and the wiring diagram of the winch.

Model B: for the XT + wireless remote control (with the switch)

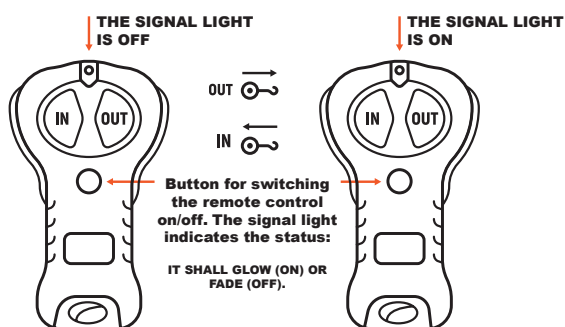

Tip: the battery is at the back. When the remote control is not in use, turn it off (the signal light is off). Keep the remote control in a dry place.

When you are not using the winch, always turn off the remote control (transmitter) and the control unit itself (red button on the relay box, if present). Otherwise the remote control battery may be discharged and the winch may start accidentally. ALWAYS turn off the remote control between successive uses of the winch, even when the interval between them is short. ALWAYS unplug the wired remote control before using the wireless remote control. ALWAYS turn off the wireless control (transmitter) and the control unit (button on the relay box - , if present). DO NOT allow children to play with any of the remote controls for the winch.

DO NOT let anyone stand or walk near the rope while working. Also keep a safe distance. This will prevent serious injury or even death if the rope breaks and “bounces” with all the energy stored in it. To prevent this, use a special sheet or even a jacket or blanket to load the rope.

ALWAYS unplug the wired remote control from the socket and turn off the control unit and the wireless remote control when you are not using the winch. The remote control may store a small amount of electricity from the battery, and its accidental activation can lead to a dangerous situation and damage to health and property.

6. Maintenance of the winch

We recommend that the winch be used at least once a month. This will allow the gear unit to be fully lubricated, so that the winch is always ready for use. It shall also increase its lifespan. For maintenance purposes, if it is not necessary to use a winch, it is enough to unwind 15m of the rope using the motor, to disengage the clutch and manually unwind an additional 5m, then re-engage the clutch and wind the rope using the motor. This type of operation also allows the motor to be kept ready for operation. Remember that it is best to wind the rope under a load of minimum 5% of the winch pulling force.

You should periodically check:

whether the winch fastening bolts are tight.
Condition of electrical connections – clean them and tighten the screws to ensure the best current flow

No other maintenance is required, except for cleaning the winch from the mud – use a brush and running water – but not a pressure washer. In case of any problems, please contact your supplier.



Should the winch be used extensively, more frequent maintenance is necessary. It may be necessary to carry out a full periodic maintenance service. If in doubt, contact your dealer.



WARNING.
The hazards and dangers related to the use of the winch as described in this manual do not cover all situations that may arise. Keep in mind that we are not able to equip the winch with caution and common sense – these are the features that must come with the user.

Almost every KANGAROOWINCH winch is equipped with a radio control system as standard. If your remote control has been damaged or the transmitter has been lost, contact your supplier.



- Before you pull the vehicle out, ALWAYS put the vehicle's gearbox to idle. Otherwise it may be damaged. If your vehicle has an automatic transmission, refer to the vehicle's manual or contact the manufacturer.



- NEVER attach the hook directly around the rope after wrapping the anchor point, e.g. a tree, with the rope. This will permanently damage the rope and may result in its breaking.



- BE CAREFUL that the rotating drum does not catch fingers, jewellery, loose parts of clothing or hair. It is best not to approach the rotating drum at all.

Thank you for purchasing our winch.

We wish you a satisfactory and safe operation.

TECHNICAL PARAMETERS OF THE WINCH

8000	
PULLING CAPACITY:	3630 kg / 8000 lbs
MOTOR:	4.4hp/3.3kw 12V, Series Wound motor
GEAR TRAIN:	3-stage planetary
GEAR REDUCTION RATIO:	216:1
CABLE/ROPE:	φ8mm×15m
DRUM SIZE:	φ2.51"×5.27" (φ64mm×134mm)
OVERALL DIMENSIONS:	(L×W×H) 17.0"×6.4"×6.7" (432mm×162mm×170mm)
GROSS WEIGHT (ROPE WINCH):	26.5kg/22.5kg
FAIRLEAD:	4-way roller fairlead or aluminum fairlead
MOUNTING BOLT PATTERN:	6.45"×4.5" (164mm×114.3)
REMOTE CONTROL:	Included

PERFORMANCE DATA						
Line pull	kg	0	907	1814	2721	3628
	lbs	0	2000	4000	6000	8000
Line speed	m/min	6,7	4,2	3,4	2,9	2,1
	FT/min	22	13,8	11,2	9,5	6,9
Motor current	AMP	75	95	192	235	320
	layer	1	2	3	4	5
Pulling capacity for respective layers	kg	3628	3145	2427	1955	-
	lbs	8000	7000	5940	4310	-
The cumulative rope length on the drum	m	3,5	8,7	13,8	15	-
	ft	11,5	28,5	45,3	49,2	-

TECHNICAL DRAWINGS AND DIAGRAMS - 8000
REPLACEMENT PARTS LIST - 8000

No.	Name	Quantity
1	inner-hexagon screws M4*16	10
2	φ4 washer	10
3	Gear box cover	1
4	Clutch pin	1
5	"O" shape ring	1
6	Spring	1
7	Clutch base	1
8	Clutch handle	1
9	Spring washer	1
10	inner-hexagon screws	1
11	Steel gasket	1
12	1& 2-stage inner gear ring	1

No.	Name	Quantity
13	Sun gear	1
14	1-stage planetary	1
15	2-stage planetary	1
16	Elastic jump ring	1
17	3-stage planetary	1
18	3-stage inner gear	1
19	paper washer	1
20	inner-hexagon screws M8*25	4
21	φ8 Spring washer	4
22	Gear box base	1
23	Water seal	2
24	Sliding bearing	2

No.	Name	Quantity
25	Drum	1
26	Support bar	2
27	Transmission shaft	2
28	Brake assembly	1
29	Motor assembly	1
30	M10 Square nut	4
31	M10 Flat washer	4
32	φ10 Spring Washer	4
33	External hexagon screws M10*35	4
34	Rope	1
35	4-Way Roller fairlead	1
36	Screws M12*25	2
37	φ12 Flat washer	2

No.	Name	Quantity
38	φ12 Spring Washer	2
39	M12 Nut	2
40	Hook	1
41	Safety belt	1
42	Remote control handle	1
43	Wireless remote control	1
44	Control box	1

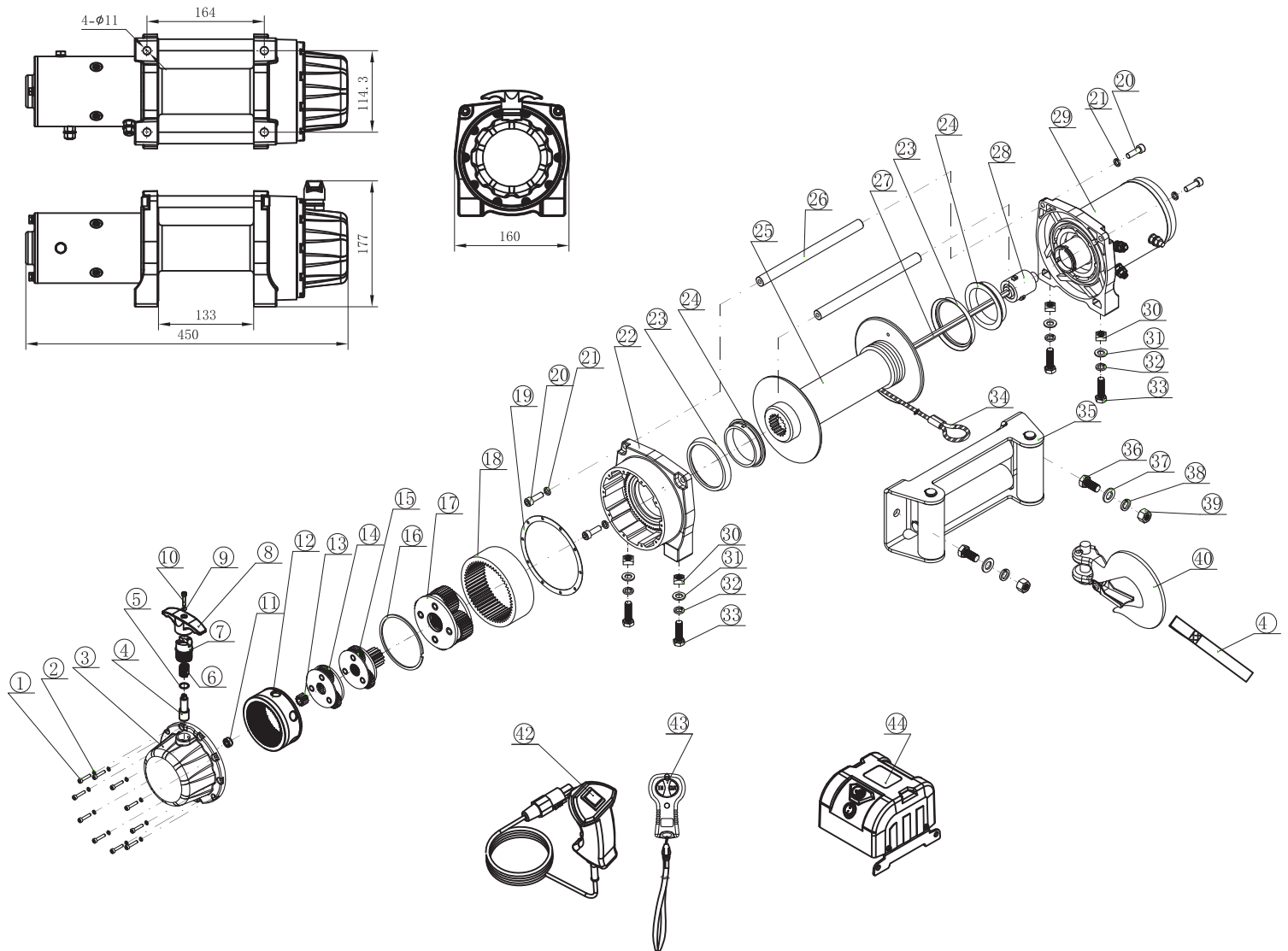

NOTES

A series of 20 horizontal dotted lines for writing notes.

TERMS OF WARRANTY

Kangaroowinch, hereinafter referred to as the Guarantor, ensures high quality and warrants efficient operation of the winch, and declares that any defects or damage revealed during the warranty period shall be repaired free of charge according to the following terms and conditions:

1. The warranty duration is 24 months from the date of issue.
2. The warranty covers winches with a valid warranty card and a proof of purchase.
3. The Guarantor undertakes to repair, free of charge, factory defects resulting from defects in materials and workmanship, if revealed during the warranty period.
4. The precondition for considering the complaint is to deliver the winch to the Guarantor or service point indicated by the Guarantor together with a valid warranty card with the serial number and/or proof of purchase and a correctly filled service request (form available from the Guarantor).
5. The Guarantor does not cover the costs of delivery of the winch.
6. The method of repair is determined by the Guarantor.
7. The repair shall be made within 15 business days from the date of delivery of the winch to the Guarantor. The period starts on the first working day after the day the winch is delivered to the service point. This period may be extended, should the repair require importing of spare parts from abroad or it is possible to be completed for reasons beyond the control of the Guarantor. The purchaser/purchaser will be notified in writing about the extension of the repair period.
8. If the winch cannot be repaired, it shall be replaced with the new one, the same, or the model with the most similar parameters. The Guarantor shall exchange it in consultation with the purchaser.
9. The warranty period is extended by the duration of warranty service. This does not apply should the repair turn out not to be covered with the warranty.
10. The warranty does not cover damage resulting from improper use or use inconsistent with the user manual, or improper storage, maintenance and lubrication of the winch.
11. The warranty shall not be honoured in the case of finding repairs, modifications, etc. of the winch made by unauthorized persons or service.
12. The warranty does not cover mechanical damage.
13. The warranty does not apply to steel or synthetic rope.
14. The warranty repairs do not include replacement of consumable parts, i.e. bearings, brushes, etc. If during the warranty repair it becomes apparent that consumable parts require replacement, the relevant costs shall be charged to the purchaser.
15. In the event that the complaint turns out to be unfounded, the Guarantor will charge the purchaser for the costs of warranty proceedings, including transport costs.
16. The Guarantor is not liable for damages resulting from improper use of the winch or use inconsistent with its intended applications.
17. The Guarantor is not responsible for the costs incurred by the purchaser in the aftermath of damage to the winch.
18. The Guarantor shall accept liability neither for the loss of time and/or profit of a real or virtual nature nor other damages resulting from the product defect or the complaint process being carried out.
19. In matters not covered by this warranty, the provisions of the Civil Code shall apply.

A request for a warranty claim form and any questions and notifications regarding this warranty should be directed to:
KANGAROOWINCH | Ul. Na Załęczu | Kraków | tel. +48 12 266 27 54 | fax. +48 12 269 63 61 | info@terenowiec.pl



NA ZAŁĘCZU 1D, 31-587 KRAKÓW
POLSKA

INFO@KANGAROOWINCH.EU
WWW.KANGAROOWINCH.EU

TEL. +48 12 266 27 54
FAX. +48 12 269 63 61